



Replaces Toro Groundsmaster 4500-D

Parts

Traction Unit - Model 30881

Rear Lift Arm

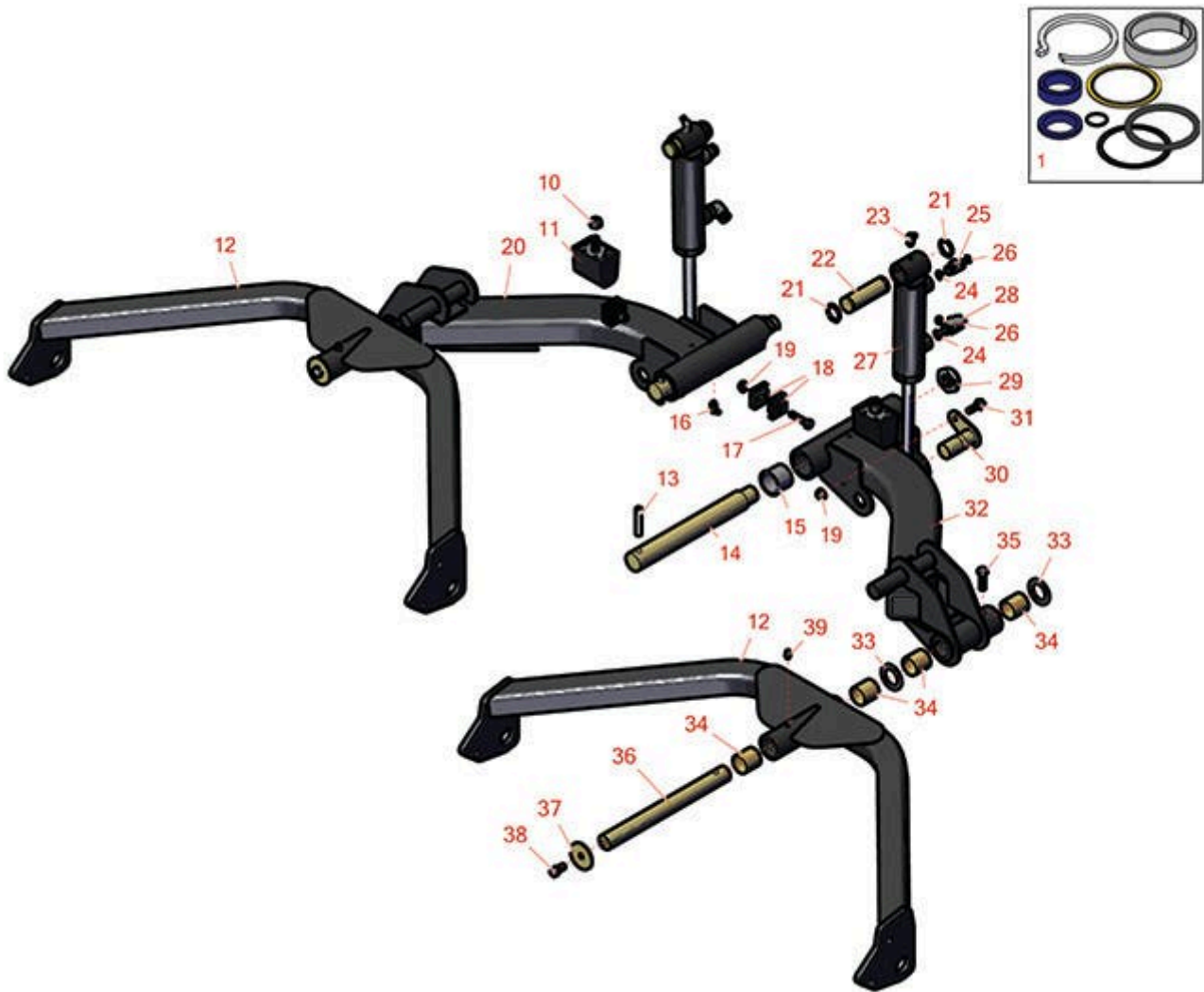

All original equipment manufacturers names and part numbers are used for identification purposes only, and we are in no way implying that our products are original equipment parts. Prices subject to change without notice.



Replaces Toro Groundsmaster 4500-D Parts

Traction Unit - Model 30881
Rear Lift Arm



Item No	R&R Part No.	OEM Part No.	Description	Qty Req	Order Quantity
---------	--------------	--------------	-------------	---------	----------------

Overhaul kit

1	R107-1977	107-1977	Seal Kit	1	
---	------------------	----------	----------	---	--

Tech Note: Fits R107-1978 Cylinder:

Other Parts Available

10	R33025-00	32025-00, 33025-00	Locknut - 10mm x 1.5 Jam	2	
11	R87-3470	87-3470	Bumper - Rubber	2	
12	R115-3453	104-5656, 115-3453	Carrier Frame Assy	2	
13	R32121-110	32121-110	Roll Pin - Slotted	2	
14	R95-7158	95-7158	Pin - Pivot	2	
15	R104-0015	104-0015, 104-8339	Bushing - Flanged	4	
16	R302-60	302-60	Zerk - Grease 90 Deg.	2	
17	R115-1794	115-1794	Bolt - Hx HD Fl 5/16-18 x 1 1/2	2	
18	R56-7973	56-7973	Clamp - Tube	4	
19	R104-8300	104-8300, 104-8300, 119-4041	Locknut - 5/16-18 Flanged Y/Zinc	2	
20	R105-9203	105-9203	No. 3 Lift Arm Assy	1	
21	R458039	32151-36	Ring - Retaining	4	
22	R92-7548	92-7548	Pin - Cylinder	2	
23	R700414	302-11, 302-19, 302-4, 32-8170	Zerk - Grease 1/4-28 45 Deg	2	

All original equipment manufacturers names and part numbers are used for identification purposes only, and we are in no way implying that our products are original equipment parts. Prices subject to change without notice.



Replaces Toro Groundsmaster 4500-D Parts

*Traction Unit - Model 30881
Rear Lift Arm*



Item No	R&R Part No.	OEM Part No.	Description	Qty Req	Order Quantity
24	R237-42	237-42, 31-4160	O-Ring	4	
25	R340-2	340-2, 60-1920	Hydraulic Fitting - Striaight	2	
26	R237-22	107-8844, 237-22, 237-78	O-Ring	4	
27	R107-1978	104-5526, 107-1978	Cylinder - Lift	2	
28	R340-77	340-100, 340-77, 95-7889	Hydraulic Fitting	2	
29	R3296-49	3296-49	Locknut - 1 in 14	2	
30	R104-5525	104-5525, 131-4201, 131-4201`	Cylinder Pin Assy	2	
31	R3234-29	3234-17, 3234-29	Bolt - 5/16-18x1 Serr Hex	2	
32	R105-9202	105-9202	No. 2 Lift Arm Assy	1	
33	R3-6781	3-6781	Washer - Thrust - Castor Wheel	4	
34	R108-4000	108-4000	Bushing	8	
35	R400264	01-150-0180, 01-178-0610, 20-48-AD, 20-48-AGD, 32-9160, 3224-3, 323-29, 323-7, 400264, 908035P	Bolt - Hex HD 3/8-16 x 1-1/4	2	
36	R105-9827	105-9827	Shaft	2	

All original equipment manufacturers names and part numbers are used for identification purposes only, and we are in no way implying that our products are original equipment parts. Prices subject to change without notice.



Replaces Toro Groundsmaster 4500-D Parts

*Traction Unit - Model 30881
Rear Lift Arm*



Item No	R&R Part No.	OEM Part No.	Description	Qty Req	Order Quantity
37	R63-7400	63-7400	Washer - Rebound	2	
38	R400258	01-150-0800, 01-178-0600, 01-178-0606, 20-45-AD, 31-0200, 31-9910, 3224-1, 323-4, 400258	Bolt - Hex HD 3/8-16 x 3/4	2	
39	R302-5	21-6010, 302-11, 302-37, 302-47, 302-5, 302-57, 302-58, 302-6, 31-0300, 32-9660, 60-0800, 62-3880, 92-4181	Fitting - Grease	2	

All original equipment manufacturers names and part numbers are used for identification purposes only, and we are in no way implying that our products are original equipment parts. Prices subject to change without notice.