

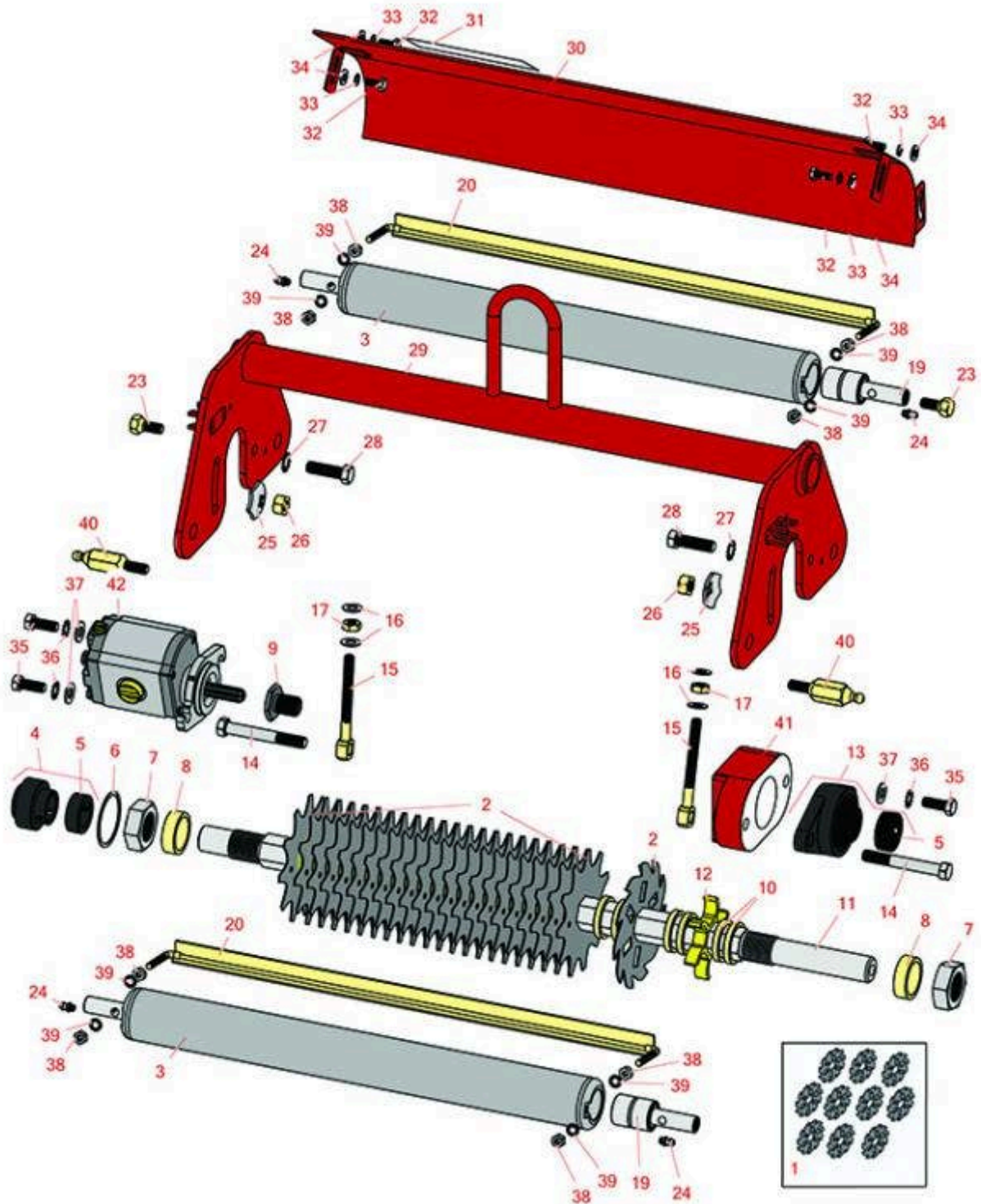

Replaces Toro Greensmaster 3050 Parts

Verti-Cut Unit - R&R Special
Verti-Cut Reel & Frame



All original equipment manufacturers names and part numbers are used for identification purposes only, and we are in no way implying that our products are original equipment parts. Prices subject to change without notice.



Replaces Toro Greensmaster 3050 Parts

Verti-Cut Unit - R&R Special

Verti-Cut Reel & Frame



Item No	R&R Part No.	OEM Part No.	Description	Qty Req	Order Quantity
---------	--------------	--------------	-------------	---------	----------------

Overhaul Kits

1	R106-6392	106-6392	Verti-Cut Blade Kit - 2mm Carbide Tipped	0	
---	------------------	----------	--	---	--

Tech Note: Includes Carbide Tipped Blades to rebuild 3 dethatching reels: 108 ea: R150209C Vertical Mower Blade:

Blades

2	R17-1590	17-1590	Verti-Cut Blade	36	
2	R150209C	106-6355	Verti-Cut Blade - Carbide Tipped 2mm	36	
2	R150109C	106-5422	Verti-Cut Blade - Carbide Tipped 1.2mm	36	

Rollers

3	R150218		Roller - V-Cut	2	
---	----------------	--	----------------	---	--

Other Parts Available

4	R251-206	251-206	Bearing	1	
5	R251-77	251-77	Collar - Bearing	2	
6	R32120-77	32120-77	Ring - Retaining	1	
7	R3220-18	3220-18, 67-5840	Nut - Jam V-Cut Shaft	2	
8	R17-1580	17-1580	Spacer - V-Cut Reel 1/2	2	
9	R10-5100	10-5100	Nut - Splined 1-1/8 Long	1	
9	R93-1394	93-1394	Nut - Splined RH Thrd .812 Long	1	
10	R17-1600	17-1600	Spacer - V-Cut Reel 1/4	72	
11	R17-1570	17-1570	Shaft - Hex Verti-Cut	1	
12	R150230		Spacer - 1/2 Ventilated V-Cut	36	
13	R251-247	251-247	Bearing - Flanged V-Cut Sft	1	

All original equipment manufacturers names and part numbers are used for identification purposes only, and we are in no way implying that our products are original equipment parts. Prices subject to change without notice.



Replaces Toro Greensmaster 3050 Parts

Verti-Cut Unit - R&R Special

Verti-Cut Reel & Frame



Item No	R&R Part No.	OEM Part No.	Description	Qty Req	Order Quantity
14	R324-13	324-13	Bolt - Hex HD 7/16 x 3-1/4	2	
15	R17-1510	17-1510	Eyebolt	2	
16	R17-1710	17-1710	Washer - Flat 3/8 Yellow USS	4	
17	R3217-7	01-188-0616, 1441, 22-13-AJD, 3217-7, 513296, 513415, 513425, 915113P	Nut - 3/8-16 Hex Plated	4	
19	R52-3180	21-6410, 52-3180	Bearing - Front Roller	4	
20	R150220		Scraper - Front / Rear Rollers	2	
23	R150219		Bolt - Rear Roller	2	
24	R302-5	21-6010, 302-11, 302-37, 302-47, 302-5, 302-57, 302-58, 302-6, 31-0300, 32-9660, 60-0800, 62-3880, 92-4181	Fitting - Grease	4	
25	R3290-334	3290-334	Washer - Lock Pyramidal	2	
26	R443114		Nut - 7/16 Hex Yellow Zinc	2	
27	R3255-16	3255-16	Washer - Lock 7/16 Ext Tooth	2	

All original equipment manufacturers names and part numbers are used for identification purposes only, and we are in no way implying that our products are original equipment parts. Prices subject to change without notice.



Replaces Toro Greensmaster 3050 Parts

Verti-Cut Unit - R&R Special

Verti-Cut Reel & Frame



Item No	R&R Part No.	OEM Part No.	Description	Qty Req	Order Quantity
28	R324-6	01-150-1690, 01-178-0712, 20-68-AGD, 3225-3, 324-6	Bolt - Hex HD 7/16-14 x 1-1/2	2	
29	R150212		Frame - V-Cut	1	
30	R17-1530	17-1530	Shield - Grass V-Cut	1	
31	R354083	104-7729, 354083	Decal - Danger	1	
32	R329-1	329-1	Bolt - Hex HD 1/4-28 x 5/8	4	
33	R3255-7	3255-7, 76-5310	Washer - Lock 1/4 Ext Star Z	4	
34	R3256-22	24-9-BD, 3-1032, 3256-1, 3256-22, 93-0954, 93-0989	Washer - Flat 1/4 Yellow	4	
35	R323-6	01-150-0010, 01-178-0608, 20-47-AD, 20-47-AGD, 3224-2, 323-6, 49-3510, 908034P, 908332	Bolt - Hex HD 3/8-16 x 1 GR5 YZ	2	
36	R3255-9	3255-9	Washer - Lock 3/8 Ext. Star	2	

All original equipment manufacturers names and part numbers are used for identification purposes only, and we are in no way implying that our products are original equipment parts. Prices subject to change without notice.



Replaces Toro Greensmaster 3050 Parts

Verti-Cut Unit - R&R Special

Verti-Cut Reel & Frame



Item No	R&R Part No.	OEM Part No.	Description	Qty Req	Order Quantity
37	R453011	01-166-0100, 01-166-0120, 01-166-0270, 01-166-0500, 01-166-0600, 01-166-0620, 132-4593, 2356-3, 237-12, 24-10-AD, 24-11-AD, 24-11-BD, 24-12-AD, 24-12-BD, 30-9310, 32-8190, 3256-24, 3256-3, 3256-36, 3256-4, 453011, 47-9950, 48-9220, 513458, 7-0052	Washer - Flat 3/8 SAE Y/Zinc	2	
38	R3219-1	01-158-0590, 01-188-0428, 3219-1	Nut - 1/4-28	8	
39	R3254-8	3254-8	Washer - Lock 1/4 Int Star Z	8	
40	R150213		Ball Joint - Special V-Cut	2	
41	R17-1520	17-1520	Weight - Counter V-Cut	1	
42	R105-9770	10-5090, 105-9770, 26-5690, 70-9800, 94-3506, 94-3507	Hydraulic Motor - Reel Quick Release	1	

Tech Note: Fits Models 3000, 3050 & 3100:

All original equipment manufacturers names and part numbers are used for identification purposes only, and we are in no way implying that our products are original equipment parts. Prices subject to change without notice.



Replaces Toro Greensmaster 3050 Parts

Verti-Cut Unit - R&R Special

Verti-Cut Reel & Frame



Item No	R&R Part No.	OEM Part No.	Description	Qty Req	Order Quantity
42	R120-2072	100-6426, 108-6487, 112-9200, 120-2072, 93-1375	Hydraulic Gear Motor	1	

Tech Note: Fits Models 3150, 3200 & 3250--D:

All original equipment manufacturers names and part numbers are used for identification purposes only, and we are in no way implying that our products are original equipment parts. Prices subject to change without notice.