

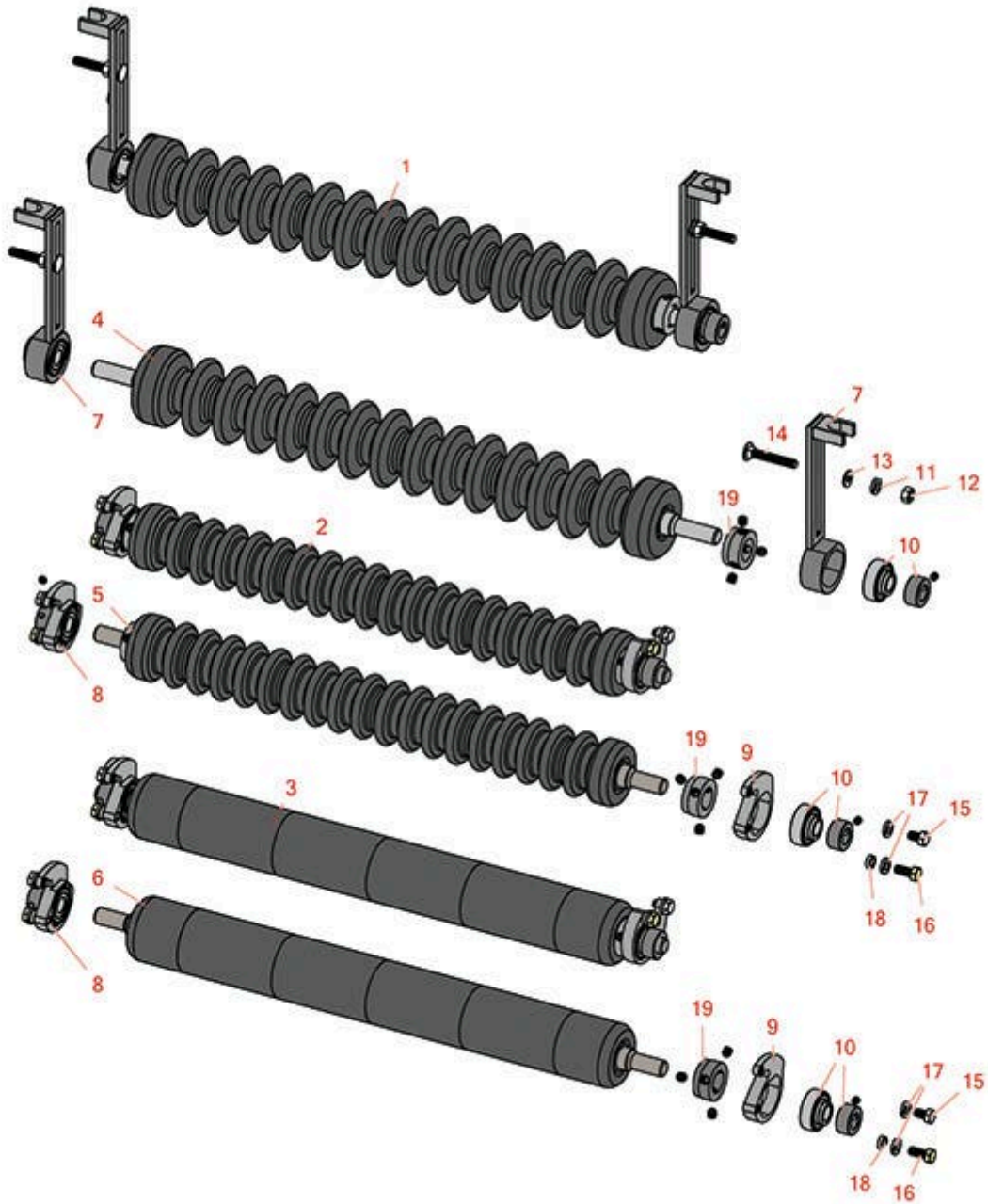

# Replaces Jacobsen LF-3400 Parts

5" Reel Units

Minuteman Roller System



All original equipment manufacturers names and part numbers are used for identification purposes only, and we are in no way implying that our products are original equipment parts. Prices subject to change without notice.



# Replaces Jacobsen LF-3400 Parts

5" Reel Units

Minuteman Roller System



Item R&R  
No Part No.

OEM  
Part No.

Description

Qty  
Req

Order  
Quantity

## Complete Minuteman Roller Systems

1	<b>RMJ3001</b>		Minuteman Front Grooved Roller System	0
---	----------------	--	---------------------------------------	---

*Tech Note: Complete roller systems include roller, two brackets with bearings and mounting hardware.:*

2	<b>RMJ3002</b>		Minuteman Rear Grooved Roller System	0
---	----------------	--	--------------------------------------	---

*Tech Note: Complete roller systems include roller, two brackets with bearings and mounting hardware.:*

3	<b>RMJ3003</b>		Minuteman Rear Smooth Roller System	0
---	----------------	--	-------------------------------------	---

*Tech Note: Complete roller systems include roller, two brackets with bearings and mounting hardware.:*

## Minuteman Rollers Only

4	<b>RM528</b>		Minuteman Grooved Roller Only	0
---	--------------	--	-------------------------------	---

*Tech Note: Use with Minuteman Roller Bracket System Only:*

5	<b>RM515</b>		Minuteman Grooved Roller Only	0
---	--------------	--	-------------------------------	---

*Tech Note: Use with Minuteman Roller Bracket System Only:*

6	<b>RM516</b>		Minuteman Smooth Roller Only	0
---	--------------	--	------------------------------	---

*Tech Note: Use with Minuteman Rollers Bracket System Only:*

## Other Parts Available

7	<b>RJ121</b>		Bracket - Front LH/RH	0
---	--------------	--	-----------------------	---

8	<b>RJ131</b>		Bracket - Rear LH	0
---	--------------	--	-------------------	---

9	<b>RJ132</b>		Bracket - Rear RH	0
---	--------------	--	-------------------	---

10	<b>RMMB157</b>		Bearing w/Locking Collar	0
----	----------------	--	--------------------------	---

11	<b>R120177</b>	120177	Washer - Lock 3/8	0
----	----------------	--------	-------------------	---

All original equipment manufacturers names and part numbers are used for identification purposes only, and we are in no way implying that our products are original equipment parts. Prices subject to change without notice.



# Replaces Jacobsen LF-3400 Parts

5" Reel Units

Minuteman Roller System



Item No	R&R Part No.	OEM Part No.	Description	Qty Req	Order Quantity
12	<b>R443110</b>	306562, 443110, 444762	Nut - 3/8-16 Hex	0	
13	<b>R453009</b>	3256-23, 452004, 452006, 452008, 453009	Washer - Flat 5/16 SAE	0	
14	<b>RMM604</b>		Bolt - Carriage 3/8-16 x 2 Gr 5	0	
15	<b>R322-1</b>		Bolt - Hex HD 5/16-18 x 1/2	0	
16	<b>R322-3</b>		Bolt - Hex HD 5/16-18 x 3/4	0	
17	<b>R446136</b>	446134, 446136	Washer - Lock 5/16 Zinc	0	
18	<b>RMM609</b>		Bushing - Aluminum Spacer	0	
19	<b>RMM3</b>		End Hub - 7/8 ID	0	

All original equipment manufacturers names and part numbers are used for identification purposes only, and we are in no way implying that our products are original equipment parts. Prices subject to change without notice.