

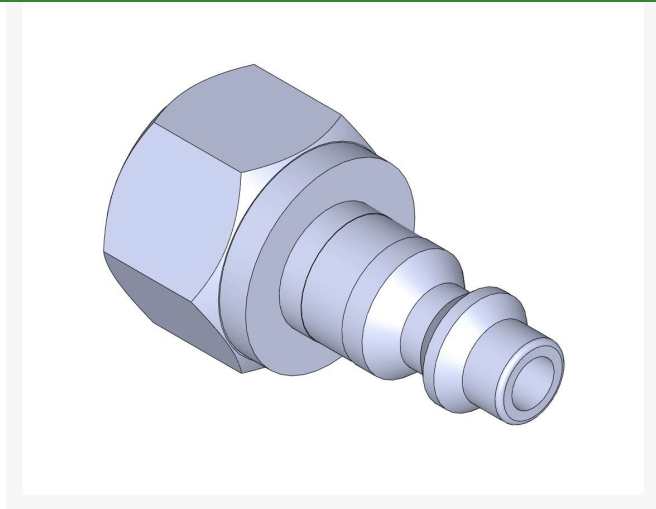

Plug - Coupler 3/8 Nptf

R5562



Details

Plated steel couplers with hardened steel balls & stainless steel springs or brass fittings that offer corrosion resistance, ductility at high temperatures, and low magnetic permeability. Maximum working pressure 300 PSI.

Specifications

Manufacturer

R&R Products

Evergreen

C/. Bartomeu Amat, 2, Entlo 1 Terrassa, 08225
+34 931 130 054

<https://evergreen.rrproducts.com/>